

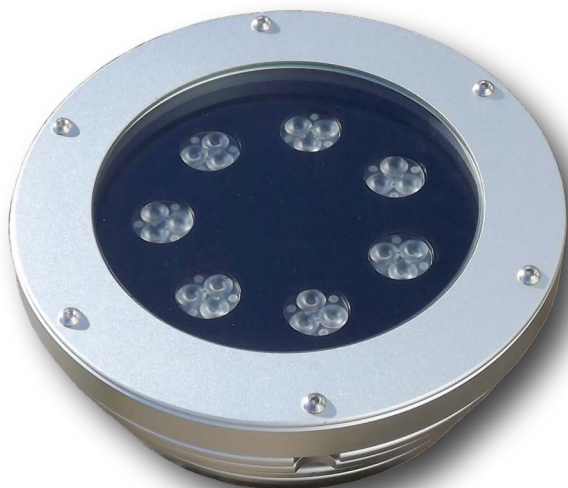











LED spotlight for outdoor installations



		STAINLESS STEEL			
12V					
		STAINLESS STEEL			
230V					

IT Apparecchio di illuminazione a LED, in alluminio anticorrosivo con finitura satinata brillante. Grado di protezione IP66 (per la versione a 230V) o IP68 (per la versione a 12V), di forma circolare, diametro 180 x altezza massima di 164 mm, cavo di alimentazione sommersibile di 2,80 m per i modelli a luce fissa e di 14,80 m per la versione RGB. La lunghezza del cavo può essere modificata su richiesta onde evitare giunzioni in zone a rischio di infiltrazione d'acqua. Con 15 Led modello NCS Nichia nei colori indicati in tabella con alimentazione 12Vac/dc o 230Vac. Con 21 LED nella versione RGB con alimentazione tramite driver 0-24Vdc. Disponibile con ottiche da 15°, 25°, 40° e 120°.

EN LED lighting device completely realised in anticorrosive aluminium with bright satin finish. Protection degree IP66 (for the 230V version) or IP68 (for the 12V version), round, diameter 180 x a maximum height of 164 mm, submersible supply cable with length of 2,80 m for fixed light models and of 14,80 m for the RGB version. The cable length can be modified on demand, in order to avoid junctions in areas where there is risk of water penetration. NCS Nichia model with 15 LEDs in the colours listed in the table, with power supply at 12Vac/dc or 230Vac. With 21 LEDs in the RGB version, power supply through driver 0-24Vdc. Available with lenses of 15°, 25°, 40° and 120°.

FR Appareil d'illumination à LED, complètement fabriqué en aluminium anticorrosif avec finition satinée brillante. Degré de protection IP66 (pour la version à 230V) ou IP68 (pour la version à 12V), de forme circulaire, diamètre 180 x hauteur maximale 164 mm, câble d'alimentation submersible de 2,80 m pour les modèles à lumière fixe et de 14,80 m pour la version RGB. La longueur du câble peut être modifiée sur demande pour éviter jonctions en lieux où il y a le risque de pénétration d'eau. Avec 15 LEDs, modèle NCS Nichia, dans les couleurs indiquées dans la table, avec alimentation 12Vac/dc ou 230Vac. Avec 21 LEDs dans la version RGB avec alimentation par driver 0-24Vdc. Disponible avec optiques de 15°, 25°, 40° et 120°.

DE LED-Beleuchtungsgerät aus antikorrosivem Aluminium mit strahlender satinierter Vollendung. Schutzart IP66 (für die 230V-Version) oder IP68 (für die 12V-Version), rund, Durchmesser 180 x maximale Höhe 164 mm, Unterwasserversorgungskabel: 2,80 m lang für die Festlichtmodelle und 14,80 m lang für die RGB-Version. Die Länge des Kabels kann auf Anfrage modifiziert werden, um Verbindungen zu vermeiden, wo es Risiko von Wasserpenetration besteht. Mit 15 LEDs, NCS Nichia-Modelle, verfügbar in den in der Tabelle gezeigten Farben mit 12Vac/dc oder 230Vac Versorgung. Mit 21 LEDs in der RGB-Version, Versorgung durch ein 0-24Vdc Driver. Verfügbar mit Optiken von 15°, 25°, 40° und 120°.

Article (lens 15°)	Article (lens 25°)	Article (lens 40°)	Article (no lens 120°)	Light source	Light colour	Wattage	Tension
PR1500/15	PR1500/25	PR1500/40	PR1500/SL	15 W POW-LED warm white	3000K	15W 2400 lumen	230Vac
PR1501/15	PR1501/25	PR1501/40	PR1501/SL	15 W POW-LED cold white	5700K	15W 3000 lumen	230Vac
PR1505/15	PR1505/25	PR1505/40	PR1505/SL	15 W POW-LED natural white	4000K	15W 2400 lumen	230Vac
PRS1500/15	PRS1500/25	PRS1500/40	PRS1500/SL	15 W POW-LED warm white	3000K	15W 2400 lumen	12V ac/dc
PRS1501/15	PRS1501/25	PRS1501/40	PRS1501/SL	15 W POW-LED cold white	5700K	15W 3000 lumen	12V ac/dc
PRS1505/15	PRS1505/25	PRS1505/40	PRS1505/SL	15 W POW-LED natural white	4000K	15W 2400 lumen	12V ac/dc
PRS21RGB/15	PRS21RGB/25	PRS21RGB/40	PRS21RGB/SL	21 W POW-LED RGB		21W 1785 lm	24Vdc with driver

Power supply	Tension
LXP35/13	Ideal for the power supply of any article of the series PERSEO (12V ac/dc) in the warm white, cold white and natural white versions
DDL1/21H	For the power supply of 1 to 5 articles of the series PERSEO RGB

For plants envisaging the use of numerous articles, contact our technical office to know the codes of the power supplies.

IT INSTALLAZIONE: Il prodotto è idoneo ad uso illuminazione di ambienti, cose, oggetti, piante o paesaggi. Nel fissaggio del prodotto con il picchetto (a terra in giardini o simili) o con la staffa in dotazione (per fissaggi a pareti o simili), occorre assicurarsi di aver fissato i vari componenti in modo sicuro e di aver stretto le viti saldamente.

EN INSTALLATION: The article is ideal for the lighting of rooms, things, objects, plants or landscapes. When fixing the product with the picket (on the ground in gardens or similar areas) or with the supplied bracket (for mounting on walls or similar), it is necessary to properly fix the various components and strongly tighten the screws.

FR INSTALLATION: L'article est idéal pour l'illumination de pièces, choses, objets, plantes ou paysages. Lors du fixation du produit parmi un piquet (sur le sol dans des jardins ou en zones similaires) ou parmi le support fourni (pour le montage au mur ou similaires), il est nécessaire de fixer correctement les différents composants et bien serrer les vis.

DE INSTALLATION: Der Artikel ist geeignet für die Beleuchtung von Zimmern, Sachen, Objekten, Pflanzen oder Landschaften. Wenn Sie das Produkt mit dem Pflock (auf dem Boden in Gärten o.ä.) oder mit der mitgelieferten Halterung (für Wandbefestigungen o.ä.) befestigen, vergewissern Sie sich, dass Sie die verschiedenen Komponenten sicher befestigt und die Schrauben fest angezogen haben.

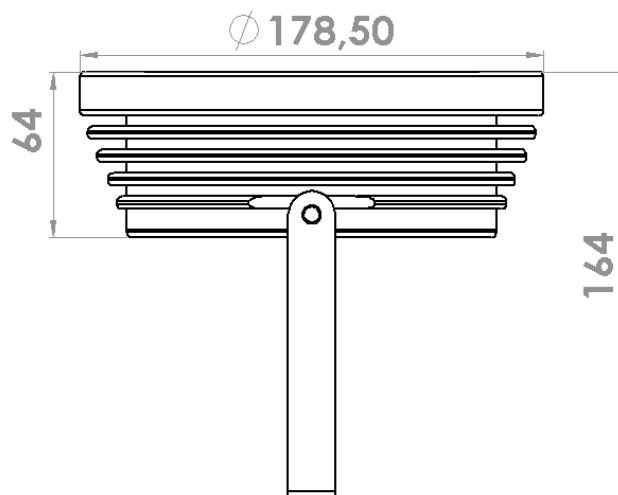

Accessories

Description

0115

Stainless steel spike for ground installations

